

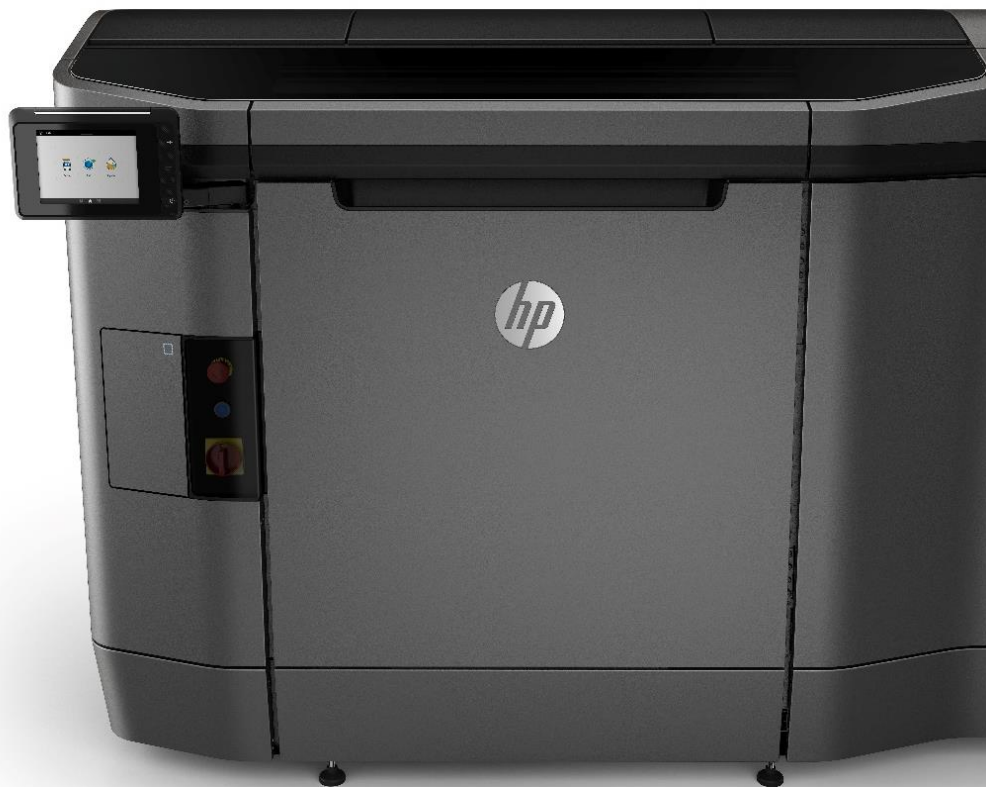

Effect of different sterilization methods on MJF parts

Author: ATC TEAM

January 2019



©Copyright 2018 HP Development Company, L.P. The information contained herein is subject to change without notice

The information contained herein is provided for information purposes only. The only terms and conditions governing the sale of HP 3D printer solutions are those set forth in a written sales agreement. The only warranties for HP products and services are set forth in the express warranty statements accompanying such products and services. Nothing herein should be construed as constituting an additional warranty or additional binding terms and conditions. HP shall not be liable for technical or editorial errors or omissions contained herein and the information herein is subject to change without notice.

Contents

Executive Summary	3
Introduction to the sterilization methods studied	3
Autoclave	3
Formaldehyde	4
Ethylene oxide.....	5
Irradiation Sterilization.....	5
Gamma Radiation	5
Electron Beam.....	5
Process followed & test done	6
Results:	8
Mechanical	8
Dimensional.....	12
Warpage.....	12
Visual	13
Weight variation	13
References	14

©Copyright 2018 HP Development Company, L.P. The information contained herein is subject to change without notice

The information contained herein is provided for information purposes only. The only terms and conditions governing the sale of HP 3D printer solutions are those set forth in a written sales agreement. The only warranties for HP products and services are set forth in the express warranty statements accompanying such products and services. Nothing herein should be construed as constituting an additional warranty or additional binding terms and conditions. HP shall not be liable for technical or editorial errors or omissions contained herein and the information herein is subject to change without notice.

Executive Summary

Sterilization is a process necessary for the complete destruction or removal of all microorganisms (including spore-forming and non-spore-forming bacteria, viruses, fungi and protozoa) that could contaminate pharmaceuticals or other materials and thereby constitute a health hazard [1]. The process of sterilization can affect the properties of plastics [2] and therefore it's important to verify the effect of the different sterilization methods on each material and take it into account during the design phase.

Different sterilizations methods have been tested to study their effect on HP 3D High Reusability PA 12. The objective is not to give advice on a specific sterilization method but to understand the effect of the different methods for single use applications such as visual models on surgeries. All the sterilizations were done with external companies or hospitals. It has been measured the variation on weight, mechanical properties and dimensional changes due to the tested sterilization methods in order to quantify their effect. On average, all the sterilization methods had an impact on the tensile modulus, lowering it approximately 20% whereas the elongation at break and the tensile strength did not suffer important variations. The irradiated samples had lower elongation at break than the ones sterilized with Autoclave or Formaldehyde.

Only in the case of Autoclave sterilization it was possible to observe marks on the samples after sterilizing.

Introduction to the sterilization methods studied

Autoclave

The autoclave sterilization-also known as steam sterilization- consists on the exposure of material in a pressurized chamber at a established temperature for certain time. It is nontoxic, inexpensive [3] and it's recommended to be used whenever possible for aqueous preparations and for surgical dressings and medical devices [1]. Commonly, cleaning and disinfection are the first steps of treatment in clinical use [4]. For this study the samples were directly autoclaved without passing through the clinical cleaning process. There are different methods to verify the efficacy of the sterilization process: Biological Indicators (BI) and Chemical Indicators that are placed in worst case positions in the load and/or in test packs [5].

Sterilization cycles typically consist of three phases:

- Pre-conditioning
- Exposure: temperature is held at the programmed temperature for the programmed exposure time.
- Post-conditioning

Table 1 summarizes different conditions possible for autoclave sterilization, with the combinations of temperature, pressure and time.

Table 1: Different sterilization conditions of temperature, pressure and time.

Temperature (°C)	Approximate corresponding pressure (kPa)	Minimum sterilization time (min)
121-124	200	15
126-129	250	10
134-138	300	5

©Copyright 2018 HP Development Company, L.P. The information contained herein is subject to change without notice

The information contained herein is provided for information purposes only. The only terms and conditions governing the sale of HP 3D printer solutions are those set forth in a written sales agreement. The only warranties for HP products and services are set forth in the express warranty statements accompanying such products and services. Nothing herein should be construed as constituting an additional warranty or additional binding terms and conditions. HP shall not be liable for technical or editorial errors or omissions contained herein and the information herein is subject to change without notice.

For this study the samples were sterilized at the Hospital Sant Joan de Déu, using a Matachana 1006E-2 Autoclave at 121°C during 25 min. (**Figure 1**) and at 134°C during 5 min. (**Figure 2**).

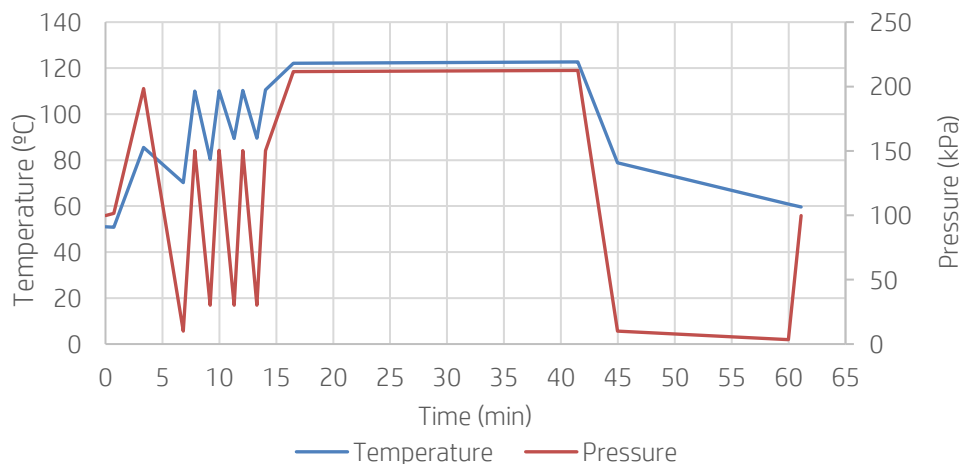

Figure 1: Cycle applied to the autoclaved samples at 121°C & 200kPa

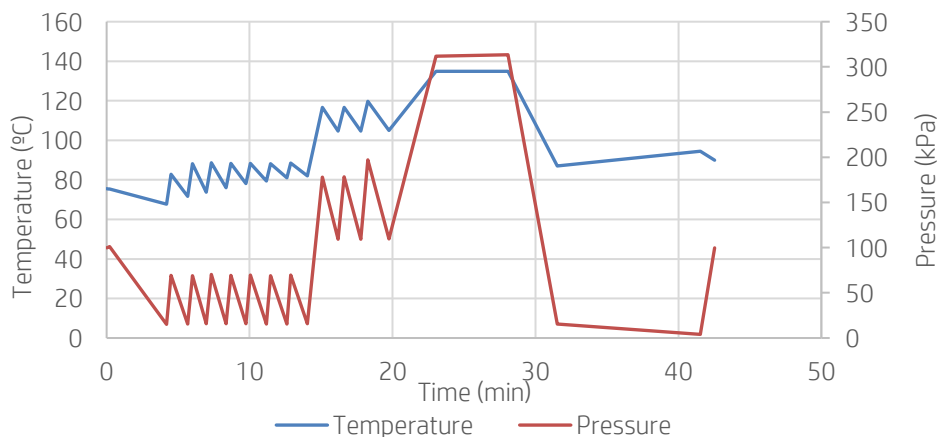

Figure 2: Cycle applied to the autoclaved samples at 134°C & 300kPa

Formaldehyde

The Formaldehyde sterilization is one of the possible low temperature methods for sterilizing temperature-sensitive materials. It is a physical-chemical processing method which combines formaldehyde gas (H_2CO) with sub-atmospheric steam.

For this study the samples were sterilized at the Hospital Sant Joan de Déu, using a Matachana 130LF sterilizer at ~60°C and the cycle applied can be seen in **Figure 3**.

©Copyright 2018 HP Development Company, L.P. The information contained herein is subject to change without notice

The information contained herein is provided for information purposes only. The only terms and conditions governing the sale of HP 3D printer solutions are those set forth in a written sales agreement. The only warranties for HP products and services are set forth in the express warranty statements accompanying such products and services. Nothing herein should be construed as constituting an additional warranty or additional binding terms and conditions. HP shall not be liable for technical or editorial errors or omissions contained herein and the information herein is subject to change without notice.

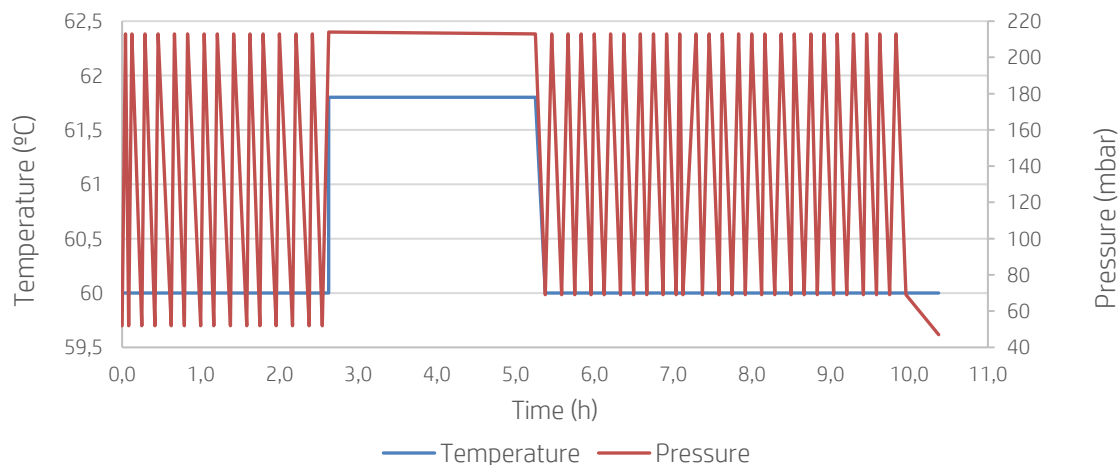

Figure 3: Cycle applied to samples sterilized with Formaldehyde.

Ethylene oxide

Ethylene oxide is another widely used low-temperature sterilization method. It's more penetrating and can operate at lower temperatures than do formaldehyde sterilizers. The highly flammable and potentially explosive nature of such the process is a disadvantage unless they are mixed with suitable inert gases to reduce their highly toxic properties and the possibility of toxic residues remaining in treated materials [1]. This method was not included in the study but is an alternative to Formaldehyde for temperature-sensitive materials.

Irradiation Sterilization

Ionizing radiation is a type of “cold” sterilization, where the piece being sterilized is not exposed to heat [2]. Radiation sterilization relies on ionizing radiation to deactivate microorganism by inducing genetic damage and chemical changes in key biological macromolecules [6]. The international unit of measure for absorbed dose is the Gray (Gy), defined as the energy absorbed by matter per unit mass (J/kg). Another common unit used is the Rad. The equivalent of 1Mrad would be 10kGy.

The most common ionizing radiation sources for sterilization applications are gamma radiation and electron beam and are the most used methods for industrial use.

Gamma Radiation

Sterilization can be achieved by exposure of matter to ionizing radiation in the form of gamma radiation from a suitable radioisotopic source such as ^{60}Co (Cobalt 60). It is usual to select an absorbed radiation level of 25kGy, although other levels may be employed once validated. For this study all the samples were sterilized at 25 kGy and a set of those samples were re-sterilized at 25kGy, which would be the equivalent to a 50 kGy sterilization.

Electron Beam

Electron beam (EB) irradiation consist on the bombardment of matter with high-energy electrons. Contrary to the gamma radiation, the e-beam process uses an electron accelerator and no radioactive source. It employs lower energy radiation and has shorter treatment times compared to gamma radiation. However,

©Copyright 2018 HP Development Company, L.P. The information contained herein is subject to change without notice

The information contained herein is provided for information purposes only. The only terms and conditions governing the sale of HP 3D printer solutions are those set forth in a written sales agreement. The only warranties for HP products and services are set forth in the express warranty statements accompanying such products and services. Nothing herein should be construed as constituting an additional warranty or additional binding terms and conditions. HP shall not be liable for technical or editorial errors or omissions contained herein and the information herein is subject to change without notice.

the penetration ability of electrons is lower than that of gamma rays, and therefore e-beam sterilization is limited in the application to lower density or smaller products [6].

For this study all the samples were sterilized at 25kGy (time exposure of 1min 50s at 35°C) and a set of those samples were re-sterilized at 25kGy, which would be the equivalent to a 50kGy sterilization (resulting exposure time of 3min 40s at 35°C).

Process followed & test done

The process followed for the study has been summarized in **Figure 4**. The objective of the study was to determine the effect of the different sterilization methods chosen on the mechanical properties and dimensional changes. For this reason, a pool of samples was printed and mechanically tested without having been sterilized to have reference values of the mechanical properties. Type 1A specimens according to ISO 527 (see **Figure 5**) were used to measure, among others, the elongation at break, tensile strength and tensile modulus.

On the other side, the samples designed to evaluate dimensional changes of the samples after sterilizing were 3D scanned before and after sterilization with an ATOS ScanBox Series 4 [7] and using the ATOS Capsule [8] optical precision measuring machine. The measures of the samples designed to measure diameters variations (see **Figure 6**) were 50mm*25mm*2mm and were printed in the XY plane.

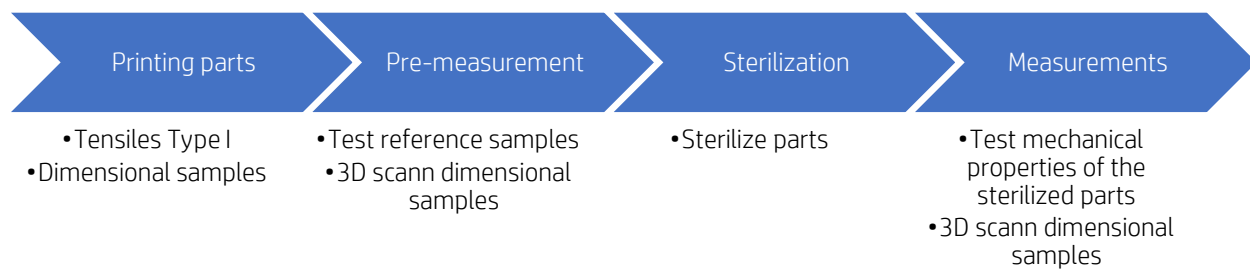

Figure 4: Test plan by steps, from printing to results analysis.

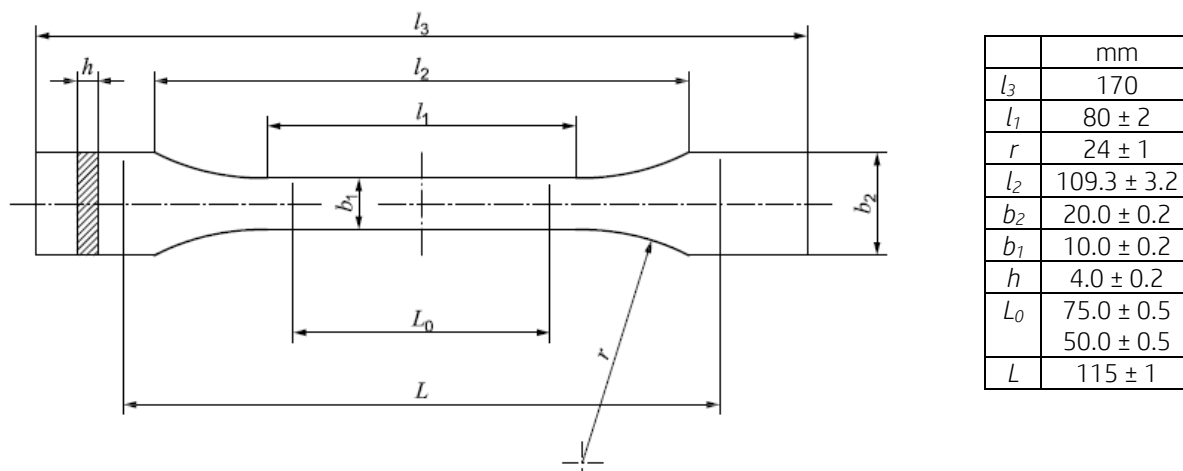

Figure 5: ISO Type 1A samples used to measure the mechanical properties.

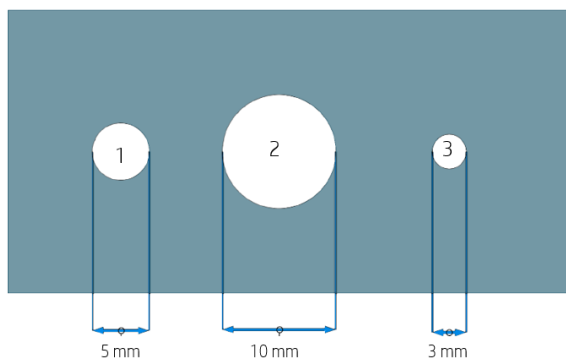

Figure 6: Design of the sample designed to measure potential variations holes' diameters.

Samples of 130mmx50mmx2mm such as the one shown in **Figure 7** were printed to evaluate the potential resulting warpage due to the sterilizations. This part was chosen as it is very prone to experience due to its thickness and dimensions. The process of measurement consisted on:

1. 3D scanning the printed part before sterilization
2. Create a CAD of the 3D printed part
3. 3D scanning the printed part after sterilization
4. Align the scanned part after sterilization with the CAD created in step 2 to get reference points.
5. The program creates a fitting plane of the surface scanned after sterilization and the CAD and measures the highest distance from the surface to the fitting plane.

©Copyright 2018 HP Development Company, L.P. The information contained herein is subject to change without notice

The information contained herein is provided for information purposes only. The only terms and conditions governing the sale of HP 3D printer solutions are those set forth in a written sales agreement. The only warranties for HP products and services are set forth in the express warranty statements accompanying such products and services. Nothing herein should be construed as constituting an additional warranty or additional binding terms and conditions. HP shall not be liable for technical or editorial errors or omissions contained herein and the information herein is subject to change without notice.

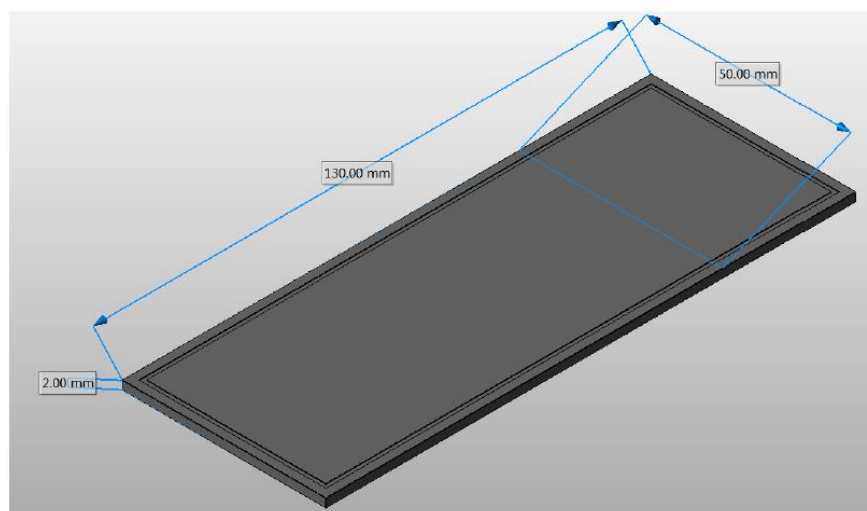

Figure 7: Sample used to measure the warpage due to the sterilization process

Results:

Mechanical

The tensile modulus, tensile strength and elongation at break were measured on the reference samples and on the samples sterilized. As it can be observed in **Figure 8**, the tensile strength did not vary with any of the sterilization methods used. The Elongation at Break on irradiated samples was more impacted than the samples sterilized with Autoclave or formaldehyde methods (see **Figure 9**): in the case of the samples irradiated using gamma radiation at 50 kGy, the samples had an elongation at break of 7.3% vs the 10.9% of the reference samples.

Independently of the sterilization method tested, all the sterilized samples exhibited a reduction of 19-21% of the tensile modulus when compared to the reference values (see **Figure 10**). On average, the resulting Tensile Modulus after sterilization is 1426 MPa, which is comparable to injection-molded PA 12 (1350 MPa in the case of the VestamidCare ML94 [9]) or with some SLS PA's materials such as P850-Black from ALM, which exhibits a tensile modulus of 1475 MPa. The system used for testing was a Zwick Allround Z050.

©Copyright 2018 HP Development Company, L.P. The information contained herein is subject to change without notice

The information contained herein is provided for information purposes only. The only terms and conditions governing the sale of HP 3D printer solutions are those set forth in a written sales agreement. The only warranties for HP products and services are set forth in the express warranty statements accompanying such products and services. Nothing herein should be construed as constituting an additional warranty or additional binding terms and conditions. HP shall not be liable for technical or editorial errors or omissions contained herein and the information herein is subject to change without notice.

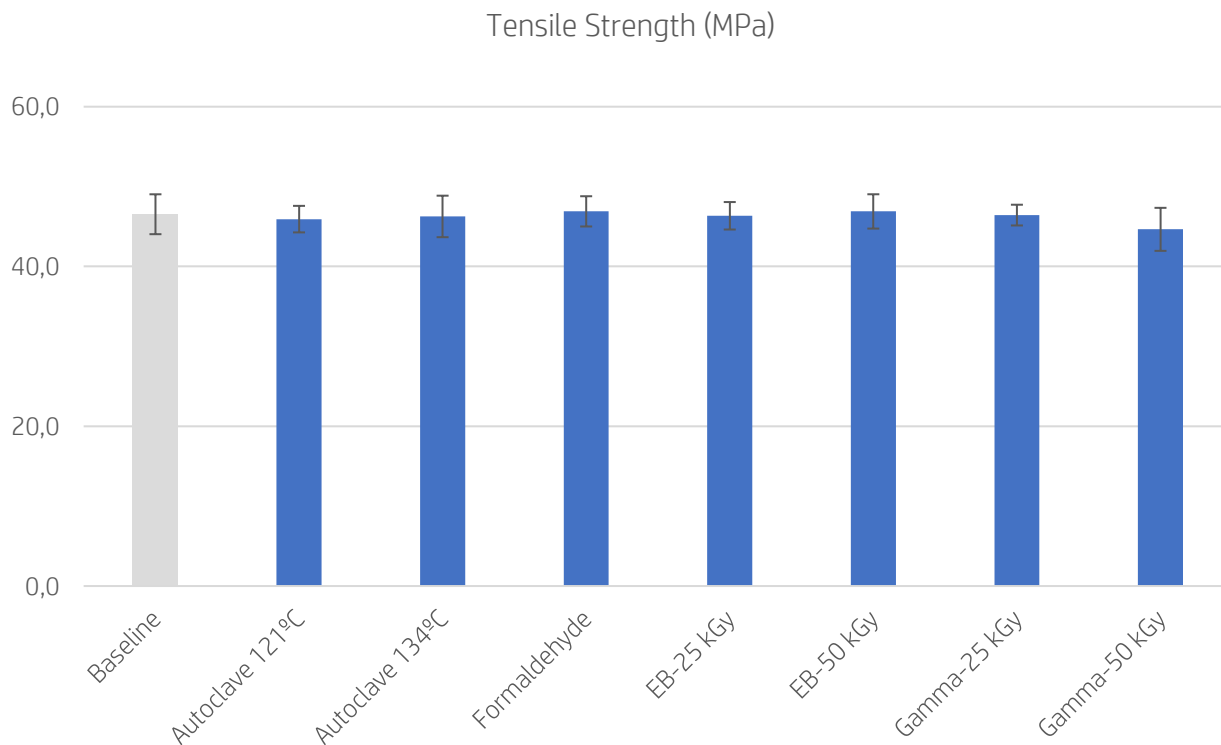

Figure 8: Tensile strength of the PA 12 samples: reference and after different sterilization methods.

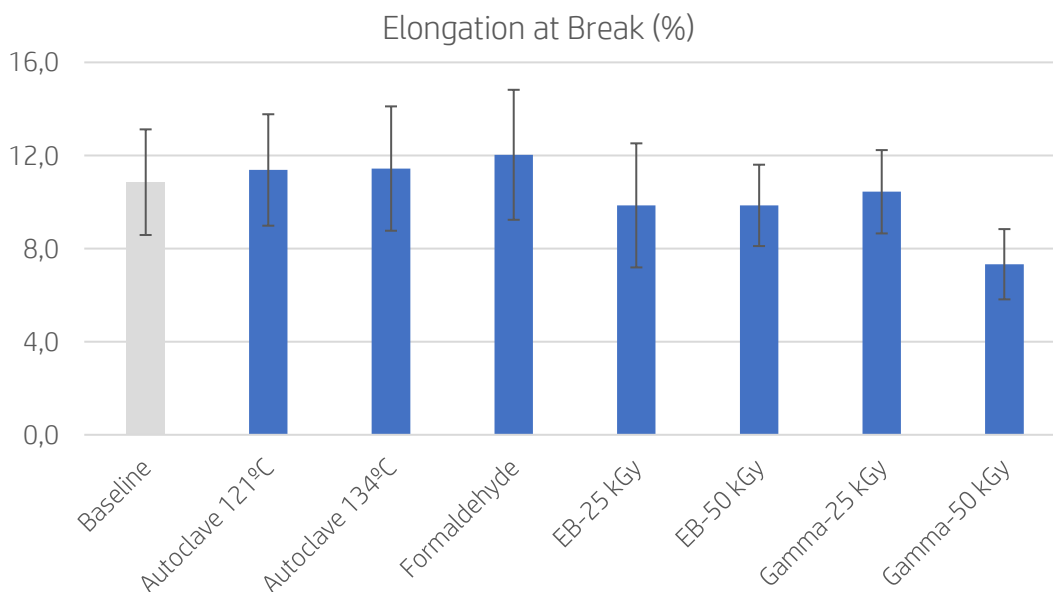

Figure 9: Elongation at Break of the PA 12 samples: reference and after different sterilization methods.

©Copyright 2018 HP Development Company, L.P. The information contained herein is subject to change without notice

The information contained herein is provided for information purposes only. The only terms and conditions governing the sale of HP 3D printer solutions are those set forth in a written sales agreement. The only warranties for HP products and services are set forth in the express warranty statements accompanying such products and services. Nothing herein should be construed as constituting an additional warranty or additional binding terms and conditions. HP shall not be liable for technical or editorial errors or omissions contained herein and the information herein is subject to change without notice.

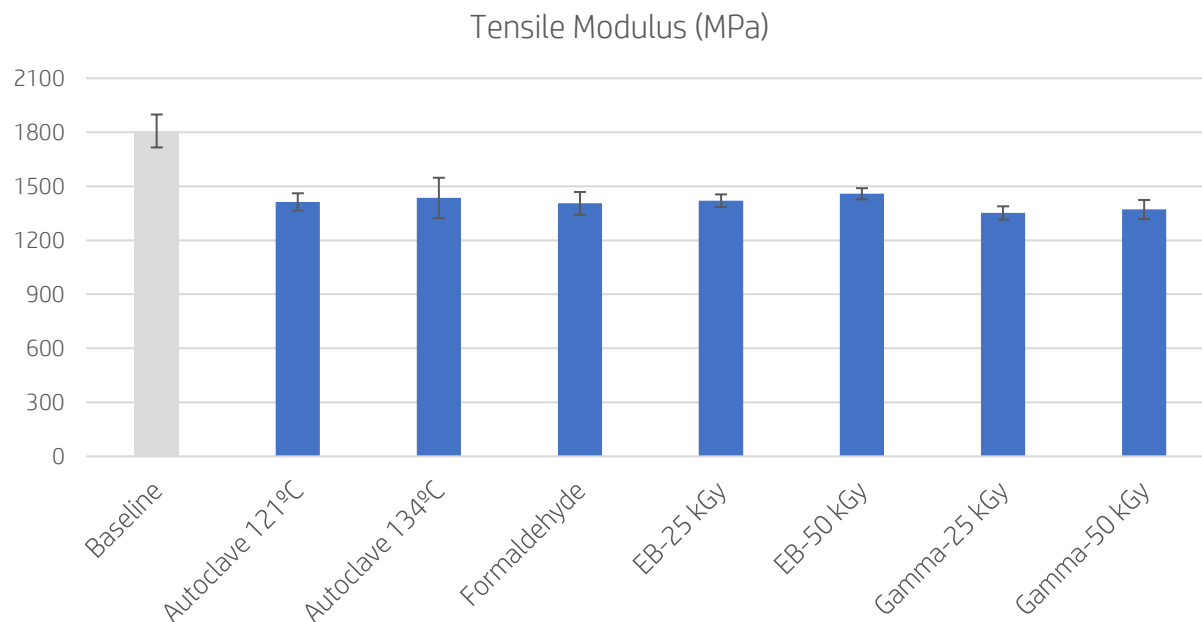

Figure 10: Tensile Modulus the PA 12 samples: reference and after different sterilization methods.

Reference values of the effect of steam sterilization on PA 12 under the same conditions have not been found on the literature. However, Miriam Johanna *et al.* [4] studied the ageing behaviour of injection molded (IM) PA 12 vs the effect of PA 12 sintered using SLS. Their study included the sterilization using autoclave, the contact of the samples with simulated body fluids & static load and cleaning/disinfection processes. It concluded that although there were some differences between IM and SLS, after 5 cycles the SLS samples retained approx. 94% of the strength and after 20 cycles relative residual strength remained above 85% for both materials.

As it is compiled in *Effect of Sterilization Methods on Plastics and Elastomers* [2], the effect of steam sterilization at 120°C on DuPont Zytel Nylon 66 after a single 200h cycle was a drop of the elongation (36% of the reference value), while the tensile strength was kept fairly similar to the reference value (101.9%).

Ionizing radiation can produce, due to cross-linking, major changes in the properties of solid polymers [10]. These two methods can be therefore used not only to sterilize parts, but to improve material properties when TAC (triallyl cyanurate, a cross linking activator) is added. As it can be seen in **Figure 12**, exposure of PA 12 samples containing the activator to high doses of gamma radiation resulted in a stiffer material. The reduction plotted in the top left is on the tensile strength at break, the strength at yield was kept stable [2].

©Copyright 2018 HP Development Company, L.P. The information contained herein is subject to change without notice

The information contained herein is provided for information purposes only. The only terms and conditions governing the sale of HP 3D printer solutions are those set forth in a written sales agreement. The only warranties for HP products and services are set forth in the express warranty statements accompanying such products and services. Nothing herein should be construed as constituting an additional warranty or additional binding terms and conditions. HP shall not be liable for technical or editorial errors or omissions contained herein and the information herein is subject to change without notice.

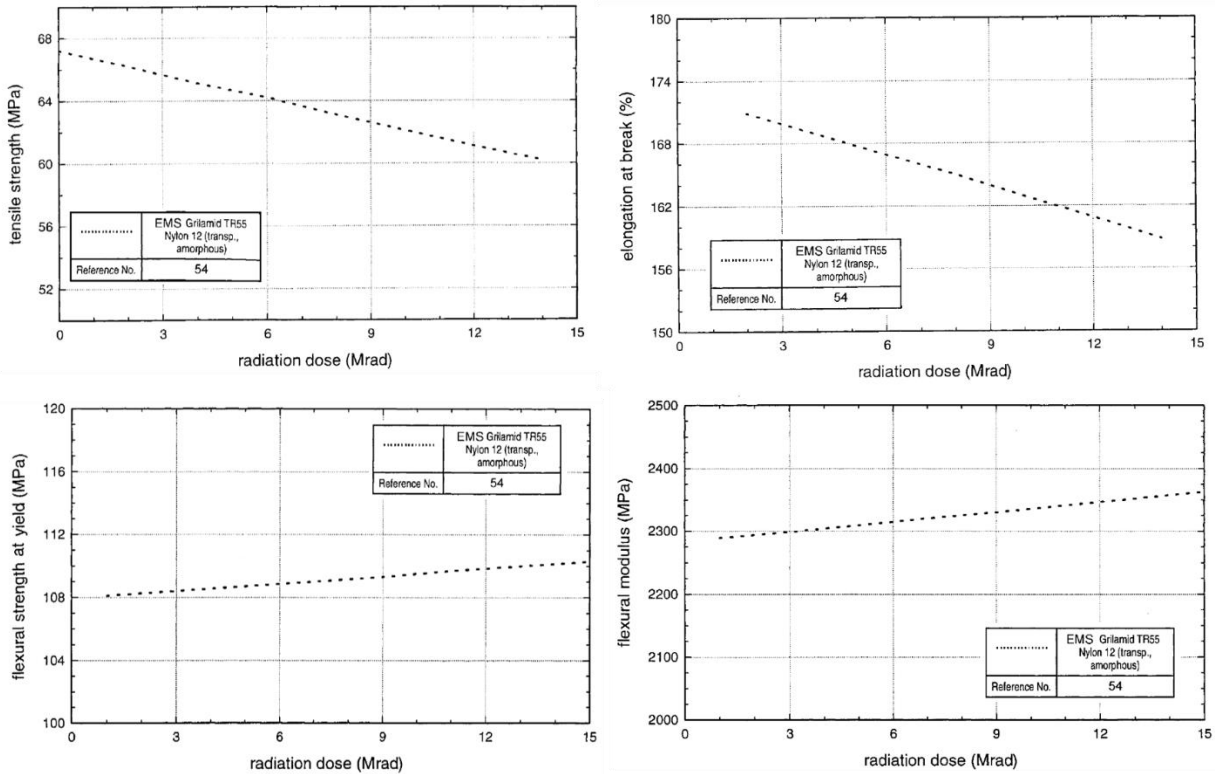

Figure 11: Effect of Gamma radiation sterilization on EMS Grivory Grilamid TR55 Nylon 12-amorphous- [2].

Another study performed by *A. Mizera et al.* [10] concluded (see **Figure 12**) that irradiations as low as 33kGy could improve both the tensile strength and modulus of PA 12 (material reference : PA 12 V-PST Creamid 12-AMN). However, the HP 3D High Reusability PA 12 doesn't contain TAC and therefore the exposure of the material to irradiation resulted on a degradation of the tensile modulus as it was observed in **Figure 10**.

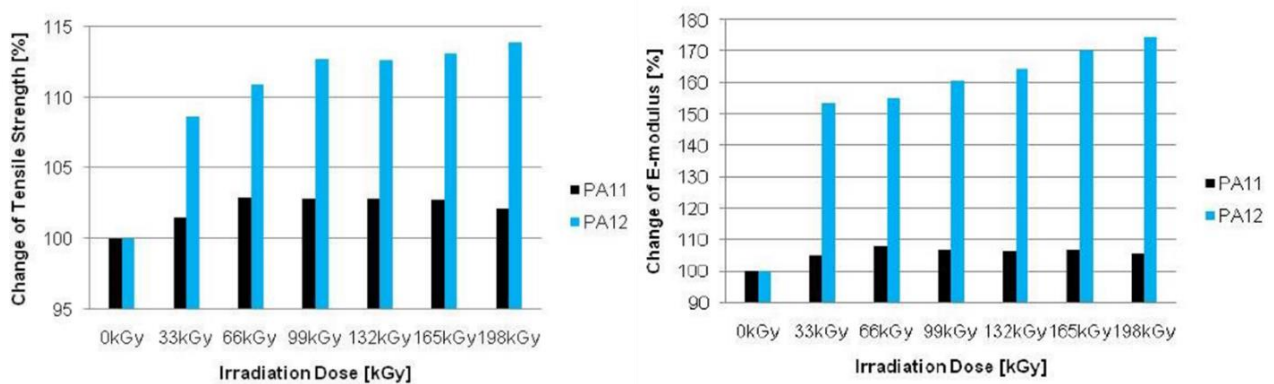

Figure 12: Effect of Gamma radiation sterilization on EMS Grivory Grilamid TR55 Nylon 12-amorphous- [2].

Dimensional

A set of samples (see **Figure 6**) were printed and 3D scanned a before and after sterilization to estimate potential deformations in certain elements due to the sterilization methods.

As it can be seen in **Table 2**, for all the sterilization methods tested the difference between the diameters measured before and after sterilization are below 15µm, except for the cylinder 1 sterilized with Gamma (25kGy). The deviation is considered negligible as it's on the scanner's accuracy range (15-20µm).

Table 2: Summary of the variation (in mm) measured of the diameters before and after sterilization.

Type of Treatment	A-121°C	A-134°C	Formaldehyde	EB-25	EB-50	Gamma-25kGy	Gamma-50kGy
Average Deviation (mm) -Cylinder 1	<0,015	<0,015	<0,015	<0,015	<0,015	0.016	<0,015
Average Deviation (mm) - Cylinder 2	<0,015	<0,015	<0,015	<0,015	<0,015	<0,015	<0,015
Average Deviation (mm) - Cylinder 3	<0,015	<0,015	<0,015	<0,015	<0,015	<0,015	<0,015

Warpage

The error plotted in **Figure 13** represents the higher distance from the surface to the fitting plane. The procedure followed can be seen in page 7. On the one side, it can be observed the samples sterilized without irradiation, the higher the temperature of the procedure the higher was the resulting warpage: Formaldehyde<Autoclave 121<Autoclave 134. On the other side, the EB samples had the lowest warpage values, being the warpage of the samples sterilized at 50kGy 3X higher than the 25kGy ones.

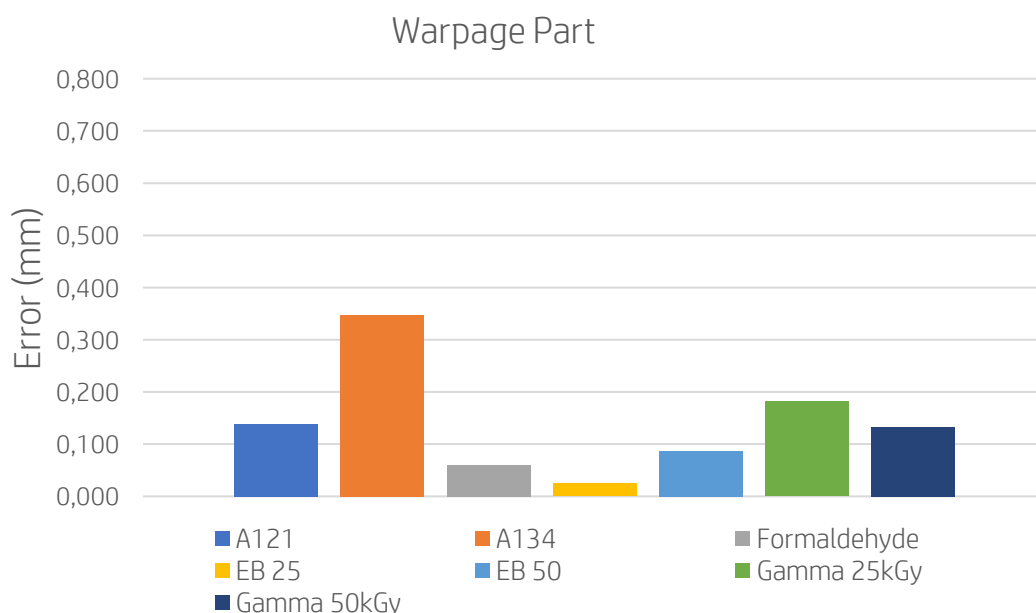

Figure 13: Design of the sample designed to measure potential variations holes' diameters.

©Copyright 2018 HP Development Company, L.P. The information contained herein is subject to change without notice

The information contained herein is provided for information purposes only. The only terms and conditions governing the sale of HP 3D printer solutions are those set forth in a written sales agreement. The only warranties for HP products and services are set forth in the express warranty statements accompanying such products and services. Nothing herein should be construed as constituting an additional warranty or additional binding terms and conditions. HP shall not be liable for technical or editorial errors or omissions contained herein and the information herein is subject to change without notice.

Visual

Measuring delta of colour was not within the scope of the study. However, a visual inspection was done to the samples sterilized. Marks were visible on the parts only in the case of the autoclaved samples (see Figure 14).



Figure 14: Type I samples after sterilization with Autoclave with visible marks.

Weight variation

Samples were weighted before and after being sent to sterilize. The increase of weight is attributed to humidity adsorbed. **Table 3** summarizes the variations measured. Non-irradiated samples (autoclave and formaldehyde) did vary the weight most likely due to the humidity trapped during the sterilization process. The EB and Gamma radiation didn't involve environments of high humidity such as in Autoclave. As a result, EB's weight variation was negligible. Weight of gamma samples was not measured.

Table 3: Weight variation of the tensile samples before and after sterilization.

Sterilization method	% weight variation
Autoclave-121°C	0.49%
Autoclave-134°C	0.37%
Formaldehyde	0.34%
EB-25kGy	0.04%
EB-50kGy	0.07%
Gamma-25kGy	N/A
Gamma-50kGy	N/A

Z

©Copyright 2018 HP Development Company, L.P. The information contained herein is subject to change without notice

The information contained herein is provided for information purposes only. The only terms and conditions governing the sale of HP 3D printer solutions are those set forth in a written sales agreement. The only warranties for HP products and services are set forth in the express warranty statements accompanying such products and services. Nothing herein should be construed as constituting an additional warranty or additional binding terms and conditions. HP shall not be liable for technical or editorial errors or omissions contained herein and the information herein is subject to change without notice.

References

- [1] "The International Pharmacopoeia-," 2016, Six Edition, Chapter 5.
- [2] L. K. Massey, Effect of Sterilization Methods on Plastics and Elastomers, William Andrew, 2005.
- [3] S. Adler, "Cost of low-temperature plasma sterilization compared with other sterilization methods," vol. 40, 1998.
- [4] M. J. Haerst, "Ageing process in laser sintered and Injection Molded PA12 following hygienic reprocessing"," 2015.
- [5] September 2018. [Online]. Available: https://www.ispe.gr.jp/ISPE/02_katsudou/pdf/201504_en.pdf.
- [6] I. Goronzy, "Radiation Sterilization-course work for PH241," 2018.
- [7] [Online]. Available: <https://www.gom.com/metrology-systems/atos-scanbox/atos-scanbox-series-4.html>. [Accessed October 2018].
- [8] [Online]. Available: <https://www.gom.com/metrology-systems/atos/atos-capsule.html>. [Accessed October 2018].
- [9] [Online]. Available: <https://materials.ulprospector.com/en/profile/default?e=239466>. [Accessed October 2018].
- [10] M. A., "Comparison of PA11 and PA12 Properties after Radiation Cross-linking".
- [11] R. J. Morrison, "Regulatory Considerations in the Design and Manufacturing of Implantable 3D-Printed Medical Devices," vol. 8.